

Termination of coaxial cables in automotive, medical and instrumentation applications utilizes a single motion to crimp the center conductor, shield and outer insulation.

GT5 Series

— Connectors for coaxial cables —

<Several types and configurations: In-line, board mounted, combinations of coaxial cable with signal/power, Multi-position and color/ keying variations.>

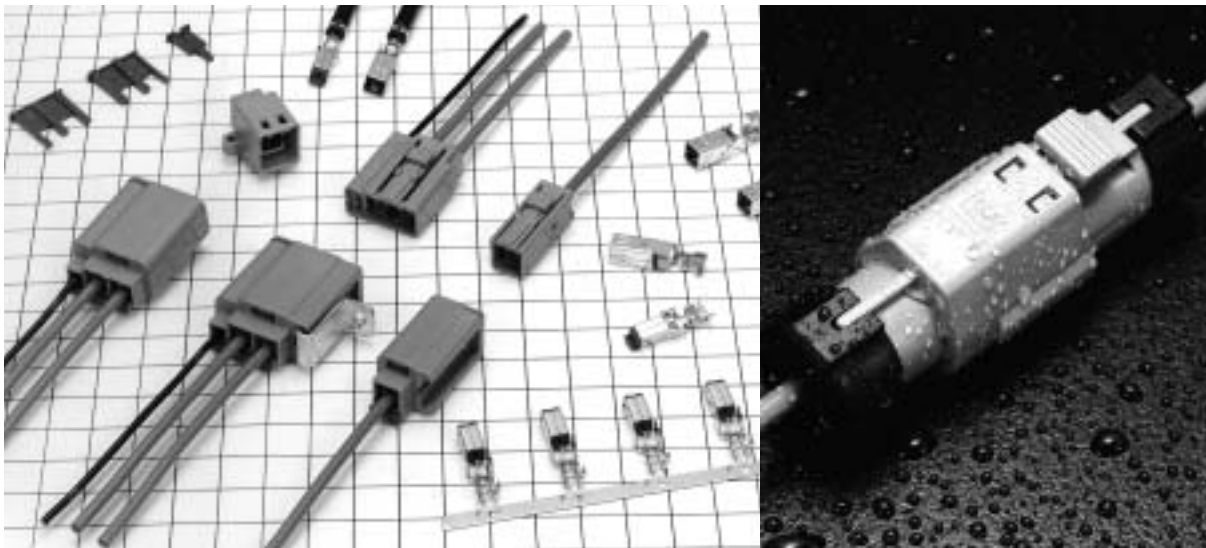

Features

- **USCAR Standard** titled "Square Outer Conductor (SAE/USCAR-19)" excludes Water Proof type (GT5W)
- **Cost efficient termination**
Highly efficient and reliable single motion "Twin Crimp™" termination allows high volume production with semi-automatic equipment.
- **Space-saving Design**
- **Lock-release latching system**
- **Shock / vibration resistant electrical connections**
- **Verification of the full contact insertion**
- **Color and polarizing variations**
- **Excellent High Frequency Performance**
Refer to V.S.W.R. data on the following pages.

Applications

In-car communication, car sensors (temperature, pressure), automotive audio systems, GPS antenna systems, RACS antenna audio/video antenna systems, CRT displays, medical and measuring instrumentation, variety of communication equipment, office automation equipment, LAN systems.

*"Twin Crimp" is a registered trade mark of Hirose Electric.

◆ Test Data (Using 1.5D-2V Type cable)

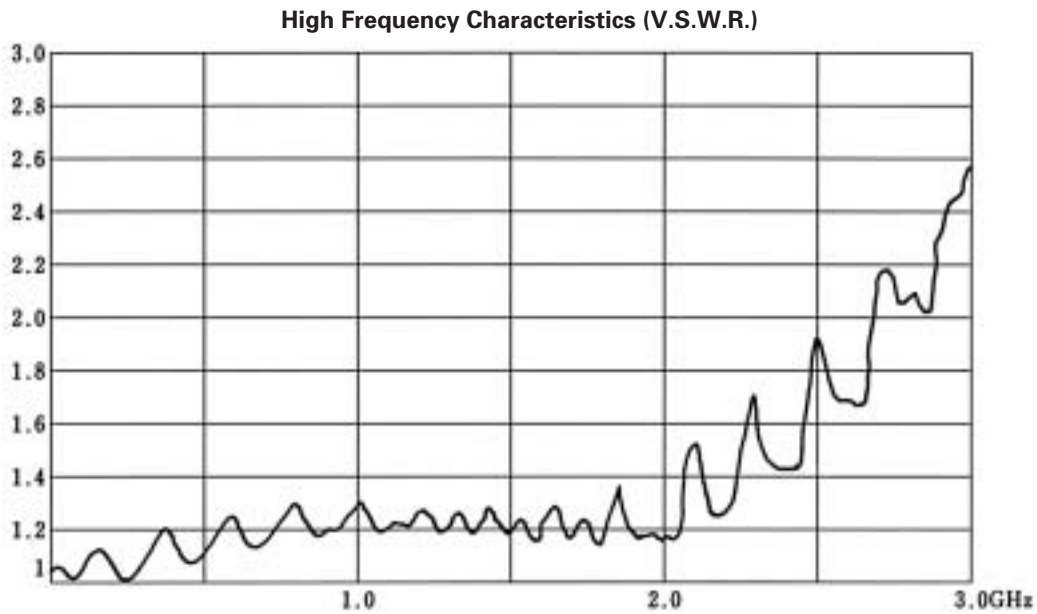

Note: Typical data using fully assembled and connected GT5-1S-HU and the GT5-1PP-HU.

◆ Termination sequence

1. Strip the cable.

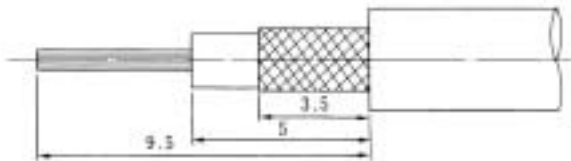

2. Crimp the cable to the terminal.

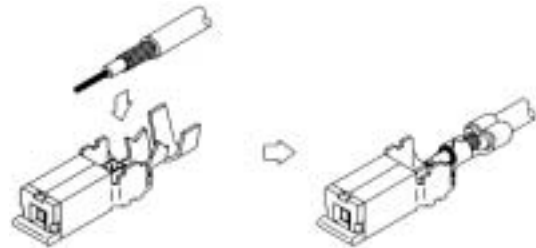

3. Insert the terminal in the housing until is fully locked.

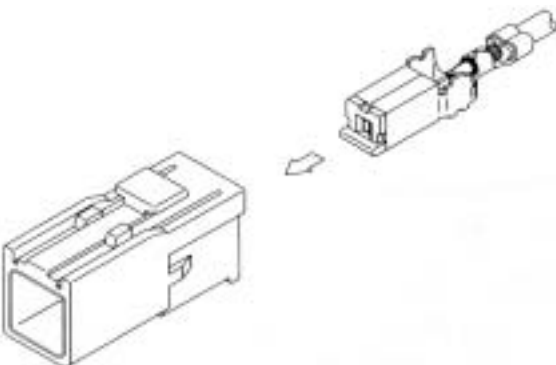

4. Fully insert the retainer.

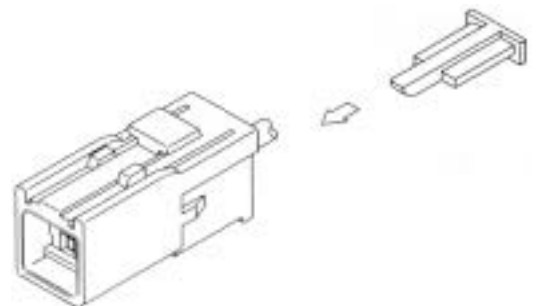

Terminals for coaxial shielded cable

F Connector Terminals

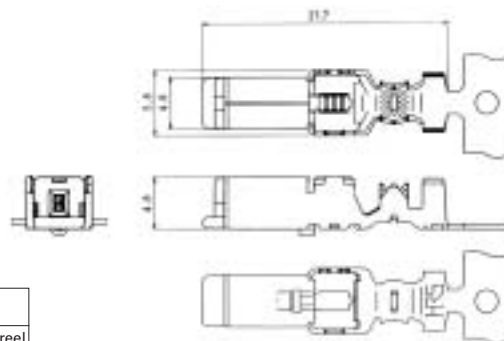

Part Number	CL No.	Conductor Size (AWG)	Inner Insulation Diameter	Outer Diameter	Packaging
GT5-30/0.7-1.5SCF	755-0065-1	#30 or equivalent	0.6 to 0.9mm	1.4 to 1.8mm	1,300 pcs. per reel
GT5-2428/1.6-2.5SCF	755-0078-3	#30 or equivalent	1.5 to 2.0mm	2.3 to 2.7mm	1,300 pcs. per reel
GT5-30/1.6-2.9SCF	755-0022-9	#24 to 28 or equivalent	1.5 to 2.0mm	2.6 to 3.4mm	1,300 pcs. per reel
GT5-2428/1.6-2.9SCF	755-0002-1	#24 to 28 or equivalent			
GT5-2022/1.6-2.9SCF	755-0071-4	#20 to 22 or equivalent	2.4 to 2.9mm	3.3 to 3.7mm	1,100 pcs. per reel
GT5-2022/F2.7-3.5SCF	755-0077-0	#20 to 22 or equivalent			
* GT5-2022/F3.3-3.8SCF	755-0054-5	#20 to 22 or equivalent	2.5 to 2.9mm	3.6 to 4.0mm	1,100 pcs. per reel
* GT5-30/3.3-5SCF	755-0016-6	#30 or equivalent	2.5 to 2.9mm	4.6 to 5.0mm	1,100 pcs. per reel
* GT5-2428/F3.3-5SCF	755-0012-5	#24 to 28 or equivalent			
* GT5-2022/F3.3-5SCF	755-0034-8	#20 to 22 or equivalent	3.0 to 3.6mm	4.6 to 5.0mm	1,100 pcs. per reel
* GT5-30/F4-5SCF	755-0020-3	#30 or equivalent			
* GT5-2428/F4-5SCF	755-0024-4	#24 to 28 or equivalent	2.5 to 2.9mm	4.6 to 5.0mm	1,100 pcs. per reel
* GT5-2022/F4-5SCF	755-0036-3	#20 to 22 or equivalent			

Part	Material	Finish
Insulator	PBT	Color: Dark gray
Crimp terminals	Phosphor bronze	Tin plating
Outer terminals	Brass	Tin plating

Note: Products marked with an asterisk (*) indicate polyethylene foam insulation.

M Connector Terminals

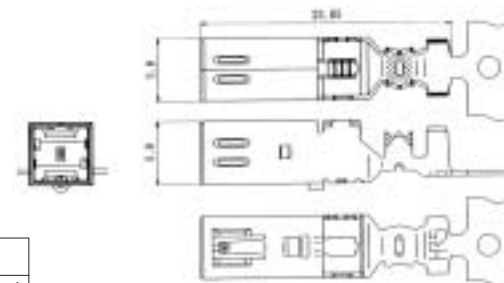

Part Number	CL No.	Conductor Size (AWG)	Inner Insulation Diameter	Outer Diameter	Packaging
GT5-30/0.7-1.5PCF	755-0017-9	#30 or equivalent	0.6 to 0.9mm	1.4 to 1.8mm	900 pcs. per reel
GT5-30/1.6-2.9PCF	755-0021-6	#30 or equivalent	1.5 to 2.0mm	2.6 to 3.4mm	900 pcs. per reel
GT5-2428/1.6-2.9PCF	755-0001-9	#24 to 28 or equivalent			
GT5-2022/1.6-2.9PCF	755-0094-0	#20 to 22 or equivalent	2.4 to 2.9mm	3.3 to 3.7mm	900 pcs. per reel
GT5-2022/F2.7-3.5PCF	755-0076-8	#20 to 22 or equivalent			
* GT5-2022/F3.3-3.8PCF	755-0053-2	#20 to 22 or equivalent	2.5 to 2.9mm	3.6 to 4.0mm	900 pcs. per reel
* GT5-30/F3.3-5PCF	755-0015-3	#30 or equivalent	2.5 to 2.9mm	4.6 to 5.0mm	900 pcs. per reel
* GT5-2428/F3.3-5PCF	755-0011-2	#24 to 28 or equivalent			
* GT5-2022/F3.3-5PCF	755-0033-5	#20 to 22 or equivalent	3.0 to 3.6mm	4.6 to 5.0mm	900 pcs. per reel
* GT5-30/F4-5PCF	755-0019-4	#30 or equivalent			
* GT5-2428/F4-5PCF	755-0023-1	#24 to 28 or equivalent	2.5 to 2.9mm	4.6 to 5.0mm	900 pcs. per reel
* GT5-2022/F4-5PCF	755-0035-0	#20 to 22 or equivalent			

Part	Material	Finish
Insulator	PBT	Color: Dark gray
Crimp terminals	Brass	Tin plating
Outer terminals	Brass	Tin plating

Note: Products marked with an asterisk (*) indicate polyethylene foam insulation.

Low-insertion M Connector Terminals

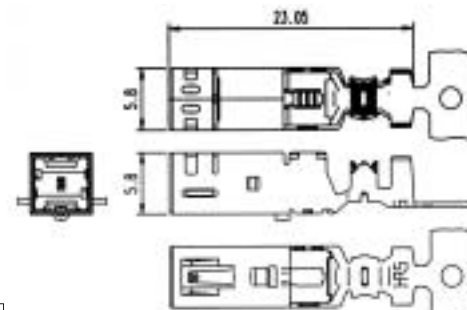

Part Number	HRS No.	Conductor Size (AWG)	Inner Insulation Diameter	Outer Diameter	Packaging
GT5L-30/0.7-1.5PCF	755-0068-0	#30 or equivalent	0.6 to 0.9mm	1.4 to 1.8mm	900 pcs. per reel
GT5L-30/1.6-2.9PCF	755-0067-7	#30 or equivalent	1.5 to 2.0mm	2.6 to 3.4mm	900 pcs. per reel
GT5L-2428/1.6-2.9PCF	755-0066-4	#24 to 28 or equivalent			
GT5L-2428/1.6-2.5PCF	755-0079-6	#24 to 28 or equivalent			

Part	Material	Finish
Insulator	PBT	Color: Dark gray
Crimp terminals	Brass	Tin plating
Outer terminals	Brass	Tin plating

For Single-Conductor coaxial shielded cable

Keying Configurations

F Connectors

Housing



GT5-1S-HU

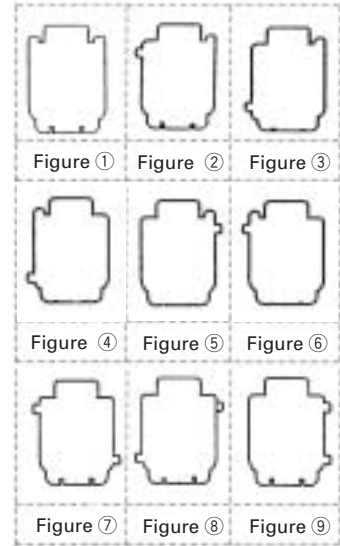

Part Number	CL No.	Material	Color	Key polarizing code	Corresponding M Connector Housing- In-line	Corresponding M Connector Assembly- Board Mounting	USCAR-19 Coding
GT5-1S-HU	755-0004-7	PBT	Light gray	Figure ①	GT5-1PP-HU	GT5-1P-DS	—
GT5-1S-HU(A)	755-0037-6		Brown	Figure ②	GT5-1PP-HU(A)	GT5-1P-DS(A)	A
GT5-1S-HU(B)	755-0038-9		Green	Figure ③	GT5-1PP-HU(B)	GT5-1P-DS(B)	B
GT5-1S-HU(C)	755-0080-5		Blue	Figure ④	GT5-1PP-HU(C)	GT5-1P-DS(C)	C
GT5-1S-HU(D)	755-0081-8		Purple	Figure ⑤	GT5-1PP-HU(D)	GT5-1P-DS(D)	D
GT5-1S-HU(E)	755-0082-0		Pink	Figure ⑥	GT5-1PP-HU(E)	GT5-1P-DS(E)	E
GT5-1S-HU(I)	Note 1		Black	Figure ⑦	GT5-1PP-HU(I)	GT5-1P-DS(I)	I
GT5-1S-HU(J)	Note 1		Cream white	Figure ⑧	GT5-1PP-HU(J)	GT5-1P-DS(J)	J
GT5-1S-HU(K)	Note 1		Pastel orange	Figure ⑨	GT5-1PP-HU(K)	GT5-1P-DS(K)	K

Shown with inserted retainer.

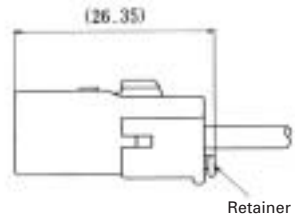

Terminal extraction tool: GT-PO(A), Note 1: concept only

Retainer (-Optional-Used with the housings: GT5-1S-HU, GT5-1PP-HU, GT5N-1PP-HU, GT5H-1PP-HU, and GT5-1PB-HU)

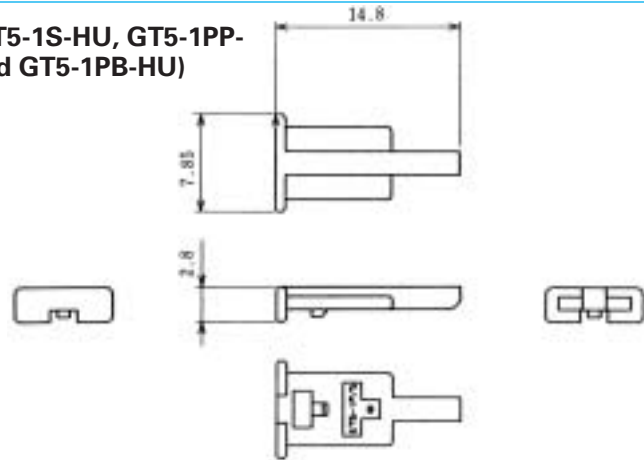

Part Number	CL No.	Material	Color
GT5-1P/S-R	755-0006-2	PBT	Dark gray

Housing (Not requiring use of the retainer)



GT5R-1S/HU

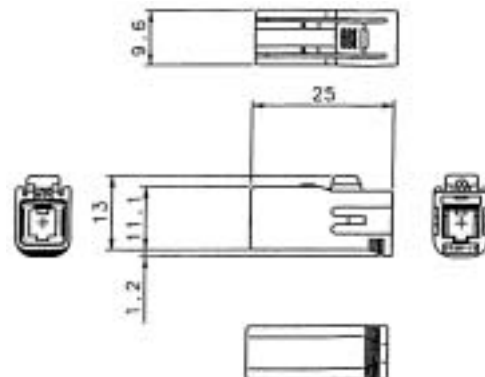

Part Number	CL No.	Material	Color
GT5R-1S-HU	755-0047-0	PBT	Light gray

Terminal extraction tool: GT-PO(A)

M Connectors

Housing

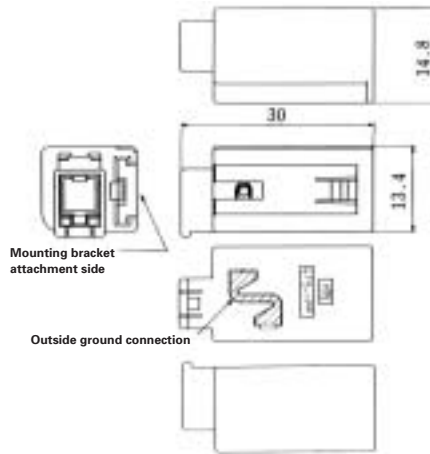

Keying Configurations

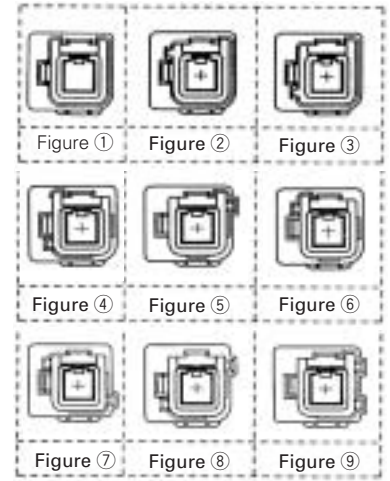

Shown with inserted retainer.

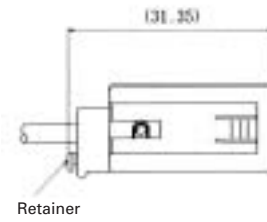

Part Number	CL No.	Corresponding F Connector Housing	Color	Key polarizing code	USCAR-19 Coding
GT5-1PP-HU	755-0005-0	GT5-1S-HU	Light Gray	Figure ①	—
GT5-1PP-HU(A)	755-0039-1	GT5-1S-HU(A)	Brown	Figure ②	A
GT5-1PP-HU(B)	755-0040-0	GT5-1S-HU(B)	Green	Figure ③	B
GT5-1PP-HU(C)	755-0103-9	GT5-1S-HU(C)	Blue	Figure ④	C
GT5-1PP-HU(D)	755-0104-1	GT5-1S-HU(D)	Purple	Figure ⑤	D
GT5-1PP-HU(E)	755-0105-4	GT5-1S-HU(E)	Pink	Figure ⑥	E
GT5-1PP-HU(I)	Note 1	GT5-1S-HU(I)	Black	Figure ⑦	I
GT5-1PP-HU(J)	Note 1	GT5-1S-HU(J)	Cream white	Figure ⑧	J
GT5-1PP-HU(K)	Note 1	GT5-1S-HU(K)	Pastel orange	Figure ⑨	K

* Refer to pages 32 and 34 for panel brackets used with in-line connectors.
 * Terminal extraction tool: GT-PO(A)
 Note 1: concept only

Part	Material	Finish
Housing	PBT	Color: Dark gray
Ground terminal	Phosphor bronze	Tin plating

Housing (For use with H type mounting bracket)

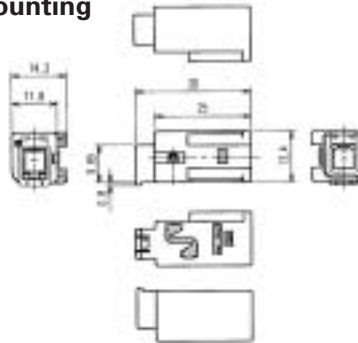

Fully mated connector assemblies.

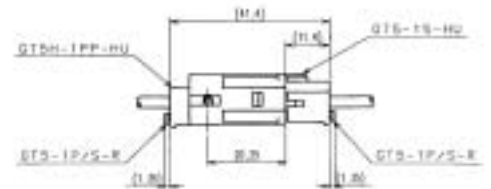

Part Number	CL No.	Color	Corresponding F Connector Housing
GT5H-1PP-HU (10)	755-0093-7 10	Light Gray	GT5-1S-HU
GT5H-1PP-HU (41)	755-0093-7 41	Blue	GT5R-1S-HU

Housing (For use with N type mounting bracket)

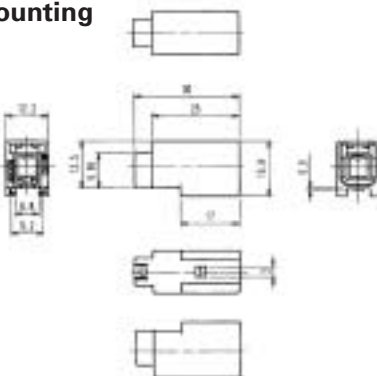

Fully mated connector assemblies.

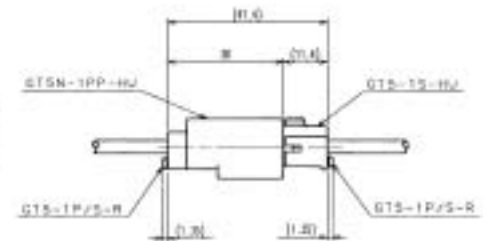

Part Number	CL No.	Color	Corresponding F Connector Housing
GT5N-1PP-HU	755-0090-9	Light Gray	GT5-1S-HU GT5R-1S-HU

● Housings

[Panel mounting, enhanced shielding configuration]

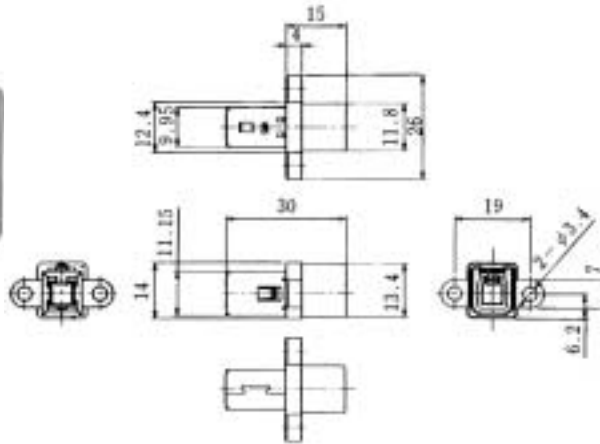

◆ Recommended Panel Cut-out

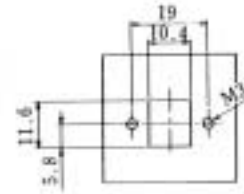

◆ Mounted and fully mated connector assemblies

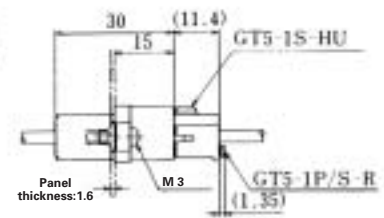

Part Number	CL No.	Part	Material	Finish
GT5A-1PP-HU	755-0025-7	Housing	PBT	Color: Light gray
		Ground terminal	Brass	Tin plating

Note 1: Terminal extraction tool: GT-PO(A)

Note 2: Retainer is optional.

Note 3: Use mounting screws of M3 with nominal diameter 3L-6 (for a panel thickness of 1.6 mm).

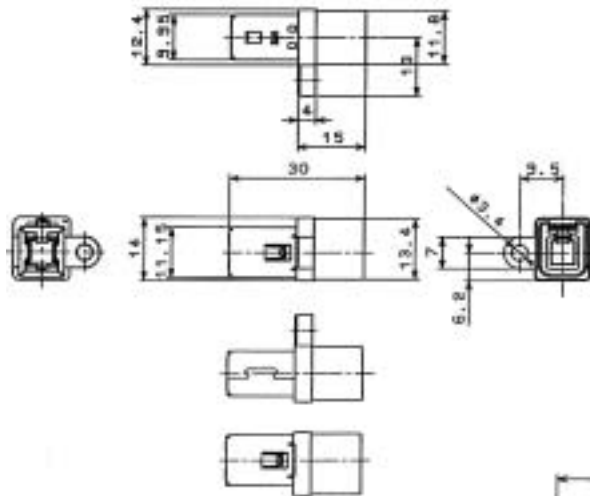

◆ Recommended Panel Cut-out

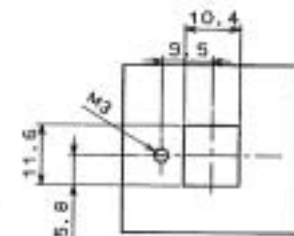

◆ Mounted and fully mated connector assemblies

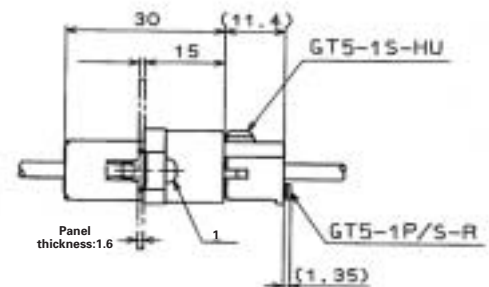

Part Number	CL No.	Part	Material	Finish
GT5P-1PP-HU	755-0030-7	Housing	PBT	Color: Light gray
		Ground terminal	Brass	Tin plating

Note 1: Terminal extraction tool: GT-PO(A)

Note 2: Retainer is optional.

Note 3: Use mounting screws of M3 with nominal diameter 3L-6 (for a panel thickness of 1.6 mm).

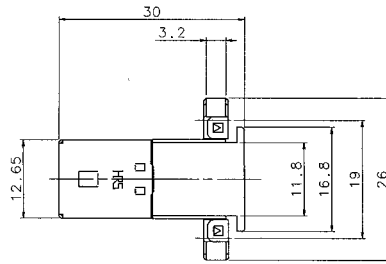

◆ Recommended Panel Cut-out

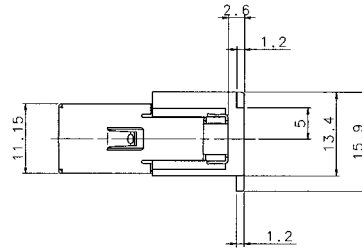
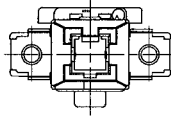
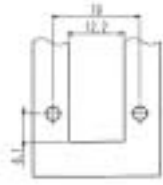

◆ Mounted and fully mated connector assemblies

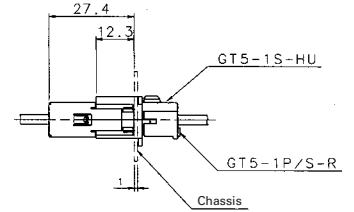

Assembly Diagram (1:1)

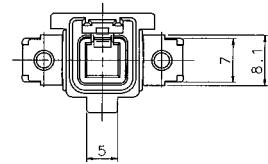

Part Number	CL No.	Part	Material	Finish
GT5B-1PP-HU	755-0051-7	Housing	PBT	Color: Light gray
		Ground terminal	Copper alloy	Tin plating

Note 1: Terminal extraction tool: GT-PO(A) with nominal diameter 3L-6 (for a board thickness of 1.6 mm).

Note 2: Retainer is optional.

Note 3: Use mounting screws of M3 with nominal diameter 3L-6 (for a panel thickness of 1.6 mm).

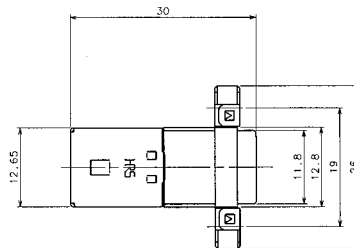

◆ Recommended Panel Cut-out

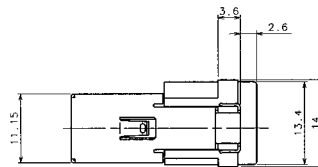
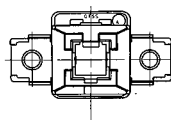
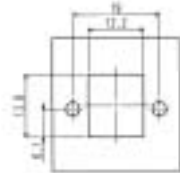

◆ Mounted and fully mated connector assemblies

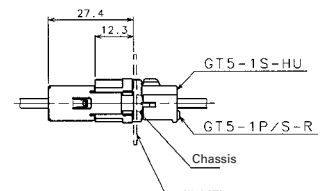

Assembly Diagram (1:1)

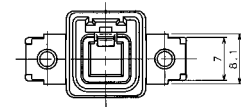

Part Number	CL No.	Part	Material	Finish
GT5S-1PP-HU	755-0050-4	Housing	PBT	Color: Light gray
		Ground terminal	Copper alloy	Tin plating

Note 1: Terminal extraction tool: GT-PO(A) with nominal diameter 3L-6 (for a board thickness of 1.6 mm).

Note 2: Retainer is optional.

Note 3: Use mounting screws of M3 with nominal diameter 3L-6 (for a panel thickness of 1.6 mm).

● Connector assembly, Printed Circuit Board Mounting Type

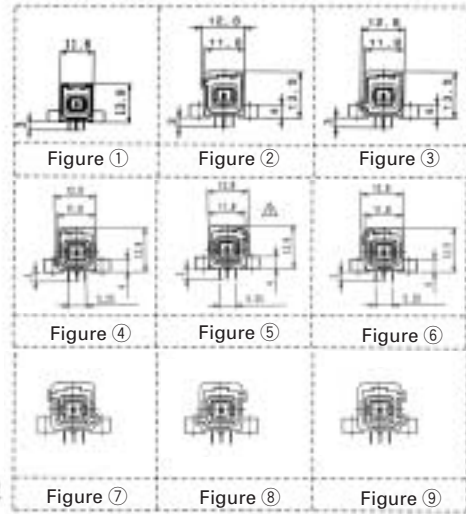
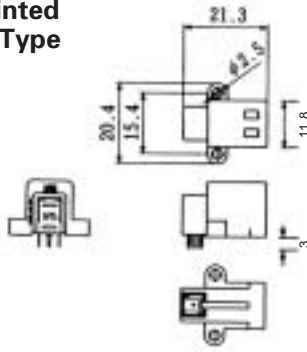

◆ Diagram of Mated Connector in Use

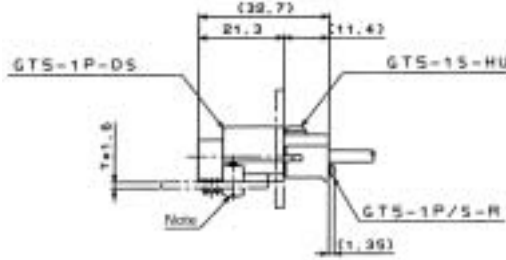

◆ Recommended PCB Mounting Pattern

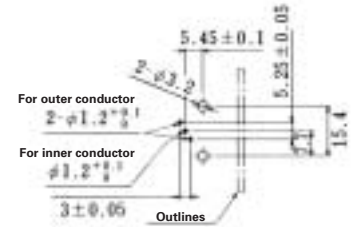

Part Number	CL No.	Color	Key polarizing code	M Connector-Board Type	Corresponding F Connector Housing
GT5-1P-DS	755-0007-5	Light Gray	Figure ①	GT5-1P-DS	GT5-1S-HU
GT5-1P-DS(A)	755-0041-3	Brown	Figure ②	GT5-1P-DS(A)	GT5-1S-HU(A)
GT5-1P-DS(B)	755-0042-6	Green	Figure ③	GT5-1P-DS(B)	GT5-1S-HU(B)
GT5-1P-DS(C)	755-0083-3	Blue	Figure ④	GT5-1P-DS(C)	GT5-1S-HU(C)
GT5-1P-DS(D)	755-0084-6	Purple	Figure ⑤	GT5-1P-DS(D)	GT5-1S-HU(D)
GT5-1P-DS(E)	755-0085-9	Pink	Figure ⑥	GT5-1P-DS(E)	GT5-1S-HU(E)
GT5-1P-DS(I)	Note 2	Black	Figure ⑦	GT5-1P-DS(I)	GT5-1S-HU(I)
GT5-1P-DS(J)	Note 2	Cream white	Figure ⑧	GT5-1P-DS(J)	GT5-1S-HU(J)
GT5-1P-DS(K)	Note 2	Pastel orange	Figure ⑨	GT5-1P-DS(K)	GT5-1S-HU(K)

Part	Material	Finish
Housing	PBT	-
0.65 x 1.1 Terminals	Brass	Tin plating
Insulator	PBT	Dark gray
Outer terminals	Phosphor bronze	Tin plating

Note1: Use mounting screws of M3 with nominal diameter 3L-6 (for a board thickness of 1.6 mm).
Note2: concept only

Two-position type-Each Single-Conductor coaxial cable

F Connectors

Housing

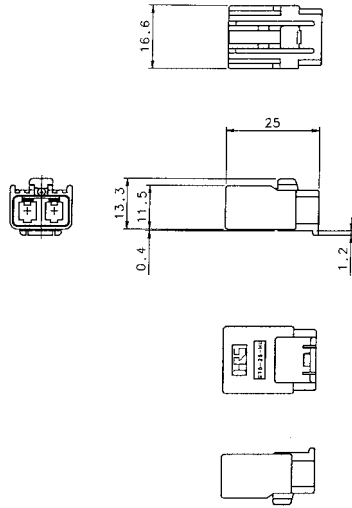
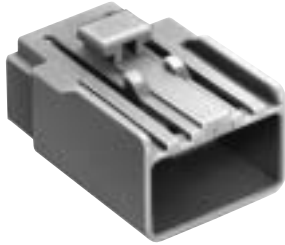

Keying Configurations

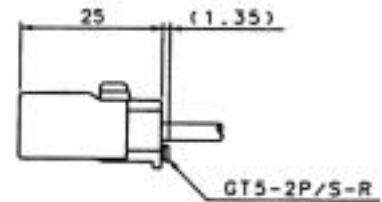
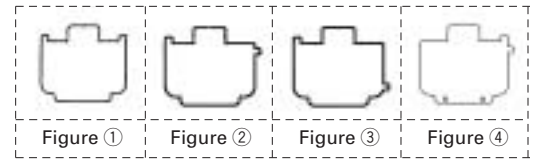

Shown with inserted retainer.

Part Number	CL No.	Material	Color	Key polarizing code	USCAR-19 Coding
GT5-2S-HU	755-0044-1	PBT	Light Gray	Figure ①	D2
GT5-2S-HU(A)	755-0059-9		Brown	Figure ②	A2
GT5-2S-HU(B)	755-0060-8		Green	Figure ③	B2
GT5-2S-HU(C)	755-0097-8		Blue	Figure ④	C2

Note 1: Terminal extraction tool: GT-PO(A)

Note 2: Used with separate retainer (GT-5-2P/S-R).

M Connectors

Housing[Panel Mounted Housing]

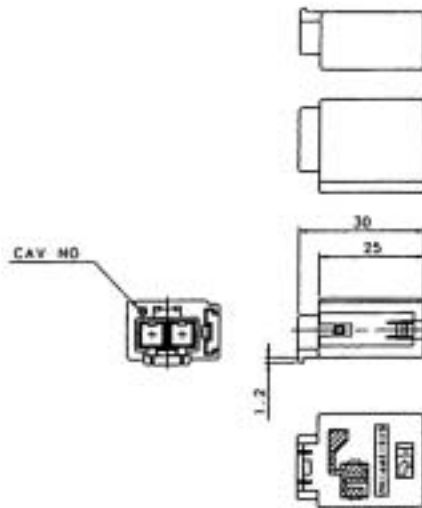

Recommended Mounting Bracket dimensions.

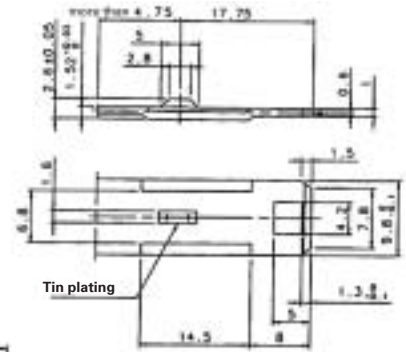

Fully mated connector assemblies

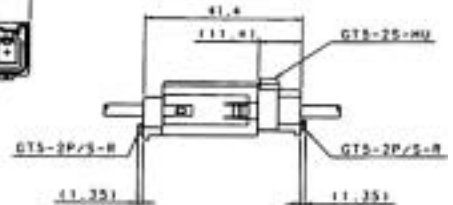

Keying Configurations

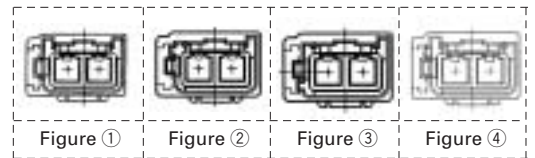

Part Number	CL No.	Color	Key polarizing code
GT5-2PP-HU	755-0045-4	Light Gray	Figure ①
GT5-2PP-HU(A)	755-0063-6	Brown	Figure ②
GT5-2PP-HU(B)	755-0064-9	Green	Figure ③
GT5-2PP-HU(C)	—	Blue	Figure ④

Part	Material	Finish
Housing	PBT	-
Ground terminal	Phosphor bronze	Tin plating

Note: Used with separate retainer (GT-5-2P/S-R).

Coding D2 at USCAR-19 is GT5-2PP-HU.

● Housing

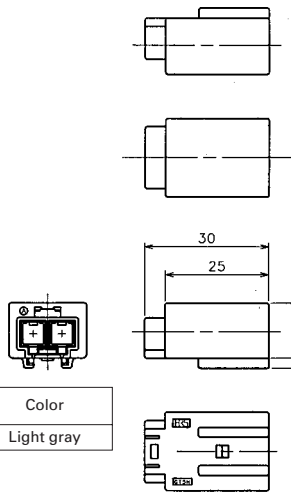

◆ Diagram of Mated Connector in Use

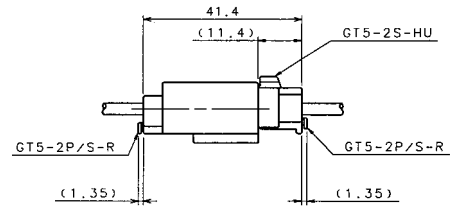

Part Number	CL No.	Material	Color
GT5N-2PP-HU	755-0055-8	PBT	Light gray

Note 1: Terminal extraction tool: GT-PO(A)

Note 2: Used with separate retainer (GT-5-2P/S-R).

● Retainer – 2 position (Used with GT5-2S-HU, GT5-2PP-HU, and GT5N-2PP-HU)

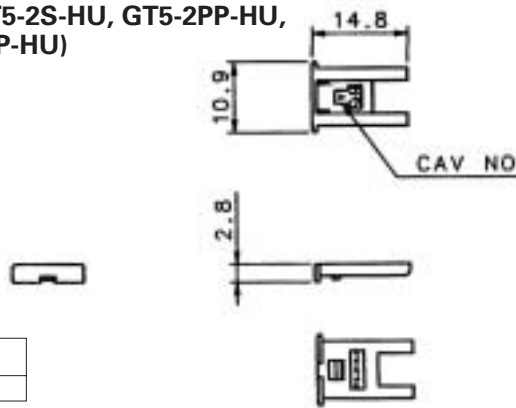

Part Number	CL No.	Material	Color
GT5-2P/S-R	755-0046-7	PBT	Dark gray

● Housing

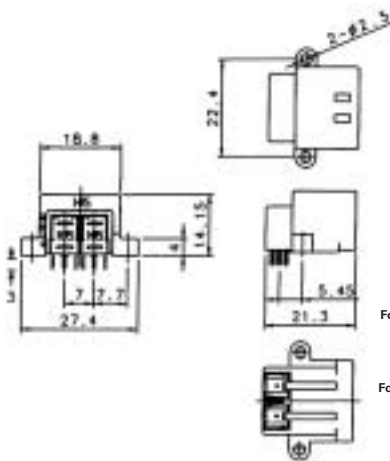

◆ Keying Configurations

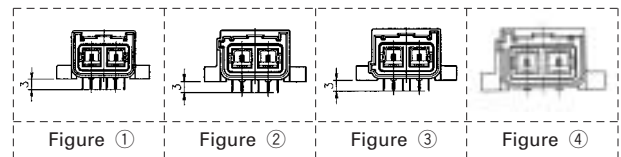

◆ Recommended Board Mounting Pattern

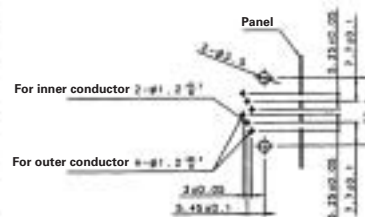

◆ Mounted and fully mated connector assemblies

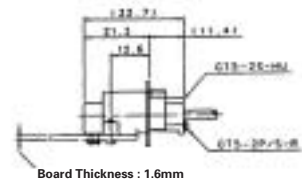

Part Number	CL No.	Material	Color	Key polarizing code	USCAR-19 Coding
GT5-2P-DS	755-0043-9	PBT	Light Gray	Figure ①	D2
GT5-2P-DS(A)	755-0061-0		Brown	Figure ②	A2
GT5-2P-DS(B)	755-0062-3		Green	Figure ③	B2
GT5-2P-DS(C)	—		Blue	Figure ④	C2

Note: Use mounting screws of M3 with nominal diameter 3L-6 (for a board thickness of 1.6 mm). Coding D2 at USCAR-19 is GT5-2P-DS.

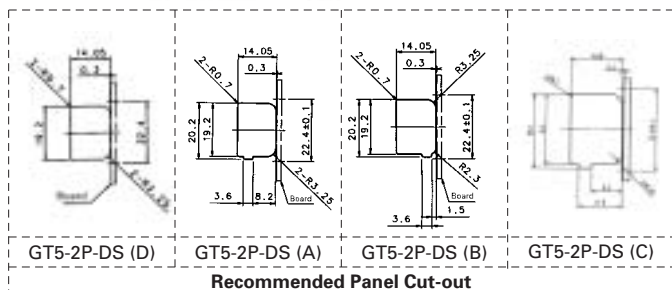

Recommended Panel Cut-out

Power Supply Terminals

(For use with combination type assemblies:

GT5-2/1S-HU, GT5-2/1P-DS, GT5-2/1PP-HU, GT5N-2/1PP-HU)

F Connector Terminals

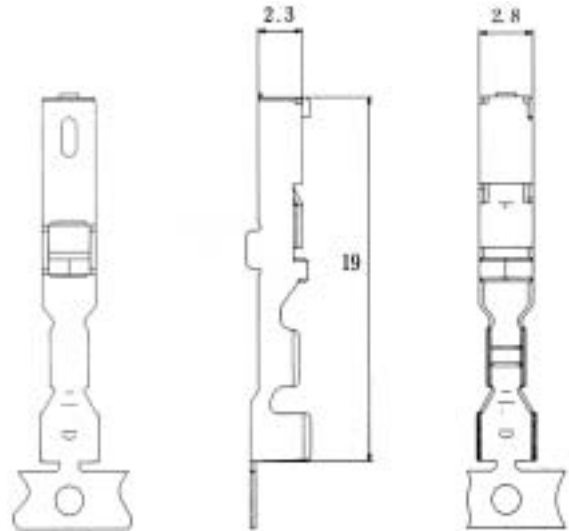

Part Number	CL No.	Material	Finish	Conductor Size (AWG)	Outer Diameter	Packaging
GT7-2022SCF	757-0001-1	Copper alloy	Tin plating	#20 to 22	1.4 to 2.4mm	5,000
GT7A-2022SCF	757-0003-7			#20 to 22	2.6 to 3.1mm	3,000

Note 1: Sold by the reel. (See above table for number of Packaging.)

Note 2: This component is used only with applicable HRS housings.

M Connector Terminals

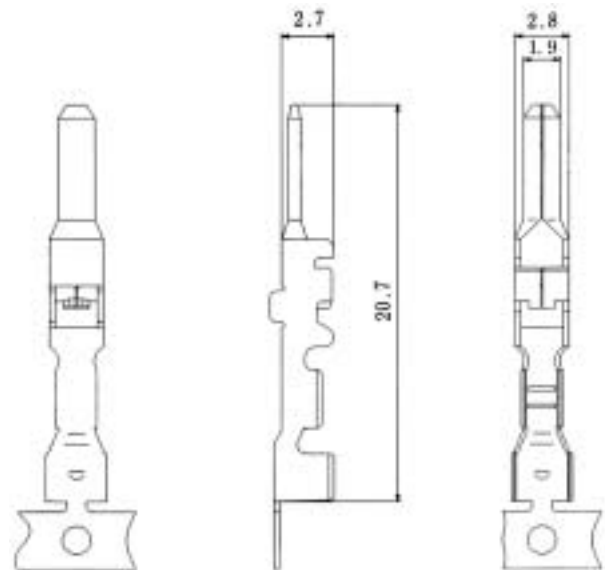

Part Number	CL No.	Material	Finish	Outer Diameter	Packaging
GT7-2022PCF	757-0002-4	Brass	Tin plating	1.4 to 2.4mm	5,000
GT7A-2022PCF	757-0004-0			2.6 to 3.1mm	3,000

Note 1: Sold by the reel. (See above table for number of Packaging.)

Note 2: This component is used only with applicable HRS housings.

Combinaton Type (Two Single-Conductor Coaxial Cables + One Power contact)

F Connectors

Housing

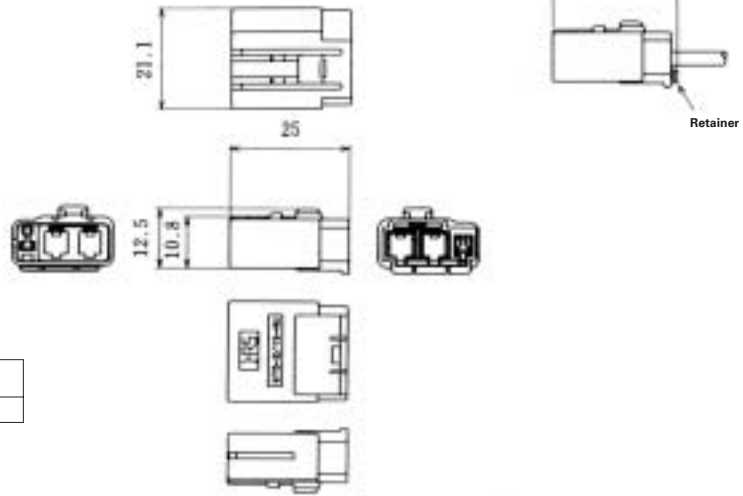

◆ Shown with inserted retainer.

Part Number	CL No.	Material	Color
GT5-2/1S-HU	755-0009-0	PBT	Light gray

Note 1: Terminal extraction tool: GT-PO(A)

Note 2: Used with separate retainer (GT5-2/1S-R).

Retainer (exclusively for GT5-2/1S-HU)

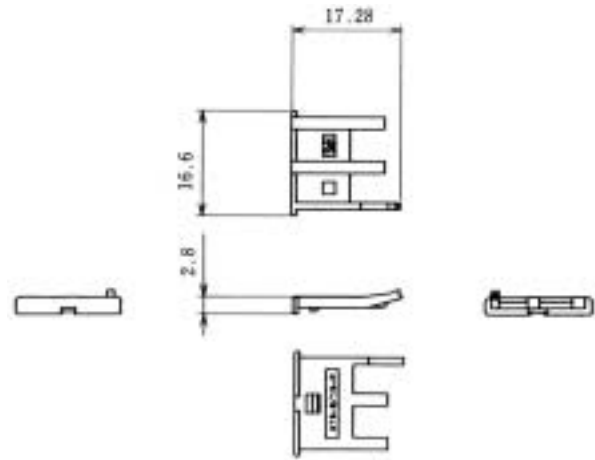

Part Number	CL No.	Material	Color
GT5-2/1S-R	755-0003-4	PBT	Dark gray

M Connectors

Connector assembly, Printed Circuit Board mounting

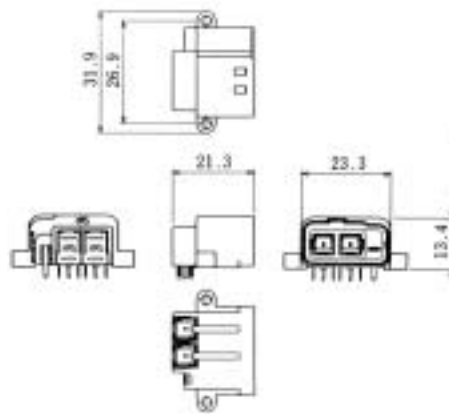

◆ Recommended Board Mounting Pattern

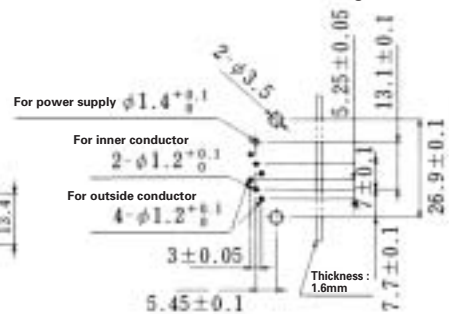

◆ Recommended Panel Cut-out

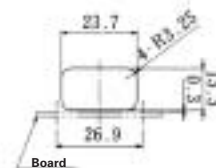

Part	Material	Finish
Housing	PBT	Color: Light gray
0.64x1.1 Terminal	Brass	Tin plating
Insulator	PBT	Dark gray
Outer terminal	Phosphor bronze	Tin plating
Tub terminal for DS 070	Brass	Tin plating

Part Number	CL No.
GT5-2/1P-DS	755-0014-0

Note: Use mounting screws of M3 with nominal diameter 3L-6 (for a board thickness of 1.6 mm).

M Connectors

● Housing - with External Ground

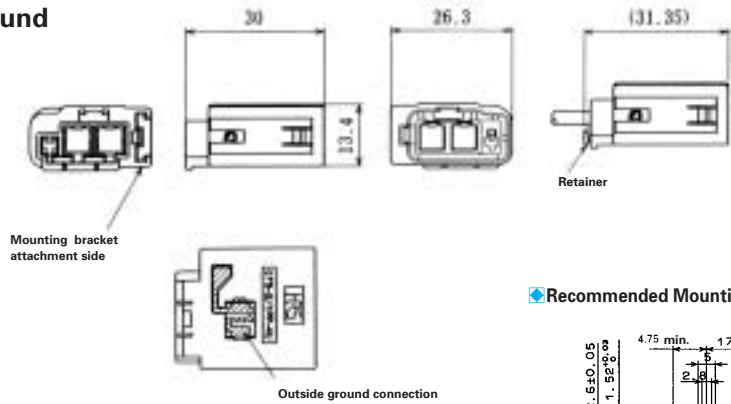

◆ Shown with inserted retainer.

◆ Recommended Mounting Bracket Dimensions

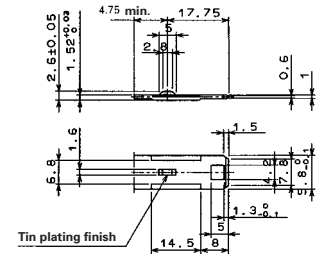

Part Number	CL No.	Part	Material	Finish
GT5-2/1PP-HU	755-0008-8	Housing	PBT	Color: Light gray
		Ground terminal	Phosphor bronze	Tin plating

Note 1: Terminal extraction tool: GT-PO(A)

Note 2: Used with separate retainer (GT5-2/1PP-R).

● Housing - without External Ground

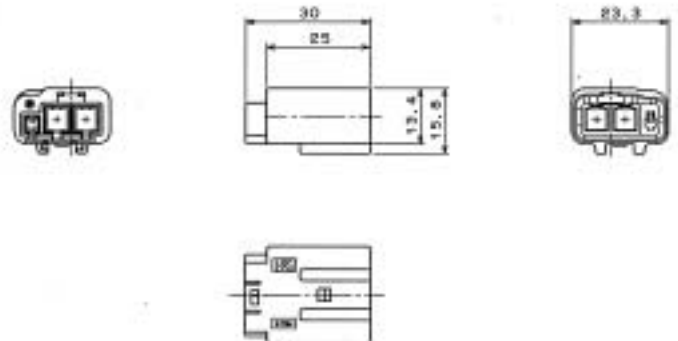

Part Number	CL No.	Material	Color
GT5N-2/1PP-HU	755-0013-8	PBT	Light gray

Note 1: Terminal extraction tool: GT-PO(A)

Note 2: Used with separate retainer GT5-2/1PP-R and mounting bracket GT-BK or GT-BK (01).

● Retainer (Used with GT5N-2/1PP-HU and GT5-2/1PP-HU)



GT5-2/1PP-R

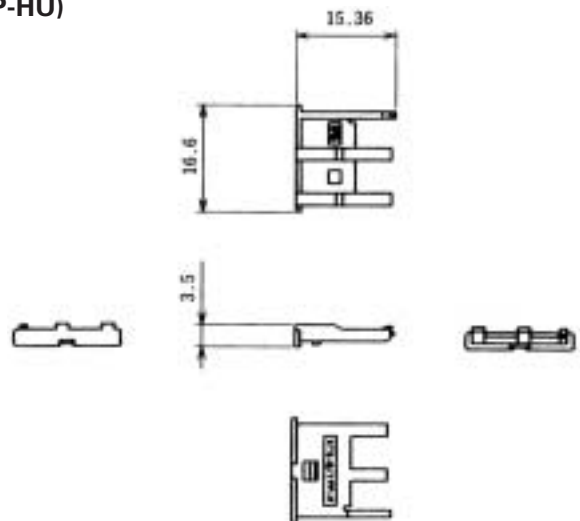

Part Number	CL No.	Material	Color
GT5-2/1PP-R	755-0010-0	PBT	Dark gray

4-Position – Single conductor Coaxial cable

◆ Shown with inserted retainer.

F Connectors

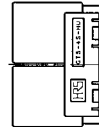
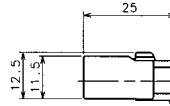
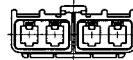
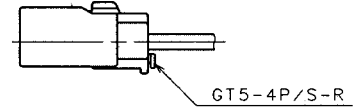
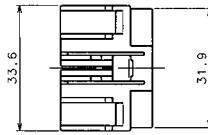

Part Number	CL No.	Material	Color	USCAR-19 Coding
GT5-4S-HU	755-0056-0	PBT	Light gray	D4

Note: Used with separate retainer (GT-5-4P/S-R).

M Connectors

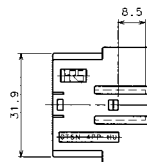
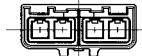
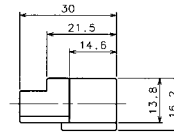
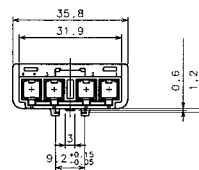
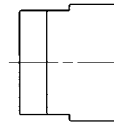

Part Number	CL No.	Material	Color	USCAR-19 Coding
GT5N-4PP-HU	755-0057-3	PBT	Light gray	D4

Note 1: The product should be used with a low-force insertion/withdrawal M connector terminal.

Note 2: Used with separate retainer GT-5-4P/S-R.

● Retainer (Used with GT5-4S-HU and GT5N-4PP-HU)

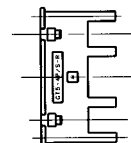
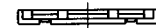
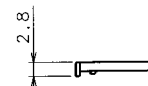
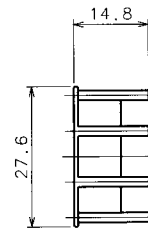

Part Number	CL No.	Material	Color
GT5-4P/S-R	755-0058-6	PBT	Dark gray

M Connectors

- Connector assembly, Printed Circuit Board Mounting

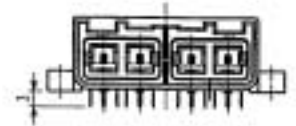
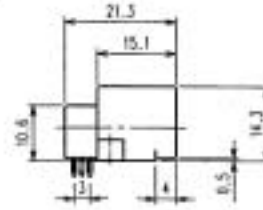
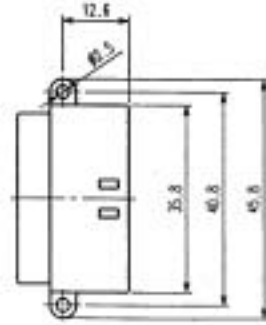
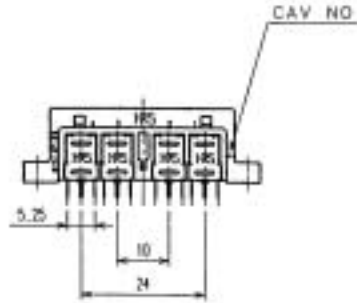

Part Number	CL No.	USCAR-19 Coding
GT5-4P-DS	755-0087-4	D4

◆ Recommended Board Mounting Pattern

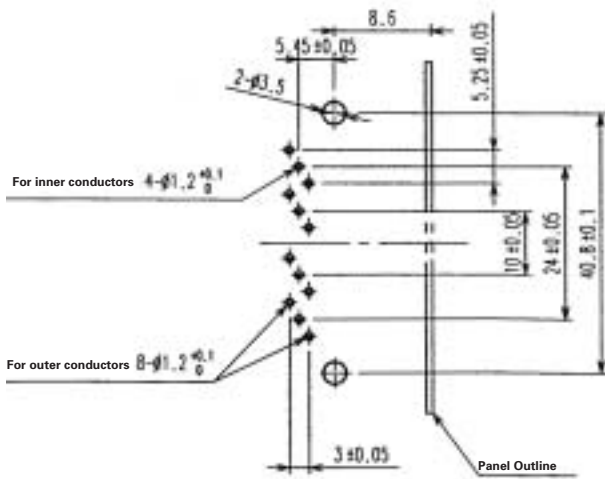

◆ Recommended Panel Cut-out

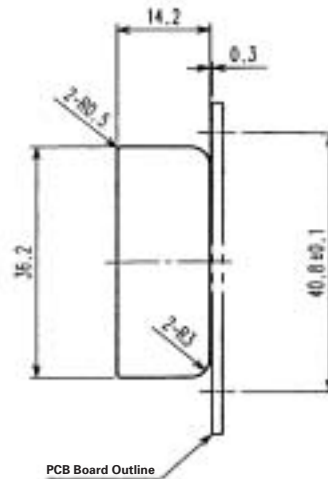

◆ Recommended Board and Panel installation

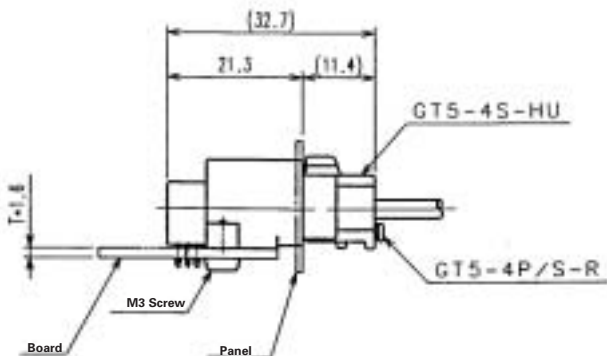

Single Conductor Coaxial Cable - Waterproof Type

F Connectors

● Housing

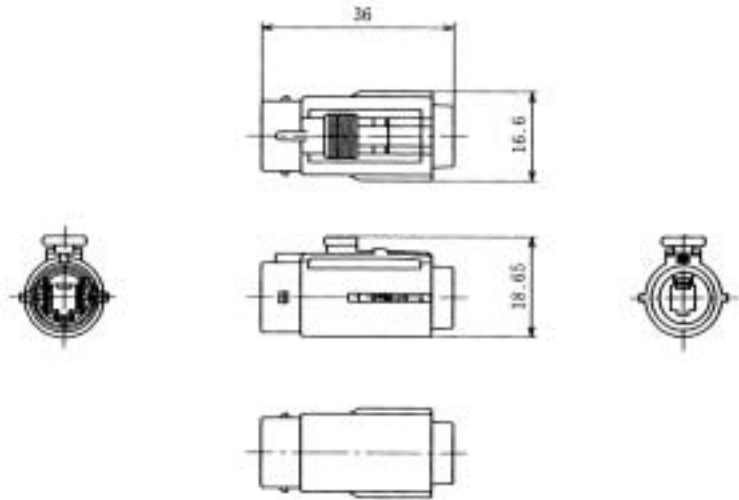

Part Number	CL No.	Material	Color
GT5W-1S-HU	755-0027-2	PBT	Light gray

Note: Specific retainer is determined by the type of the cable used.

● Retainer (Used with GT5W-1P-HU, GT5JW-1PP-HU, GT5W-1S-HU and GT5W-1P-HU)

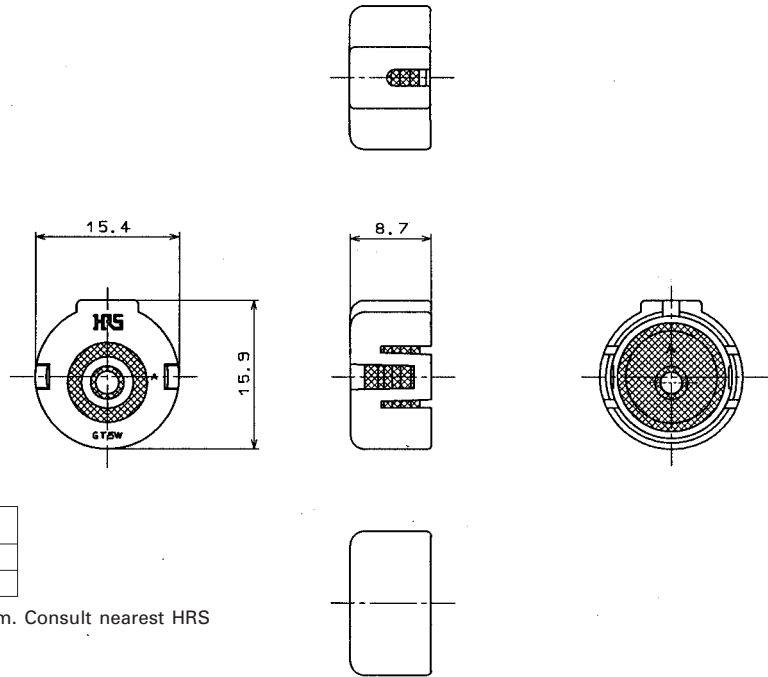

Part Number	CL No.	Material	Color
GT5W-1P/S-R	755-0028-5	PBT	Dark gray
		Silicon rubber Compound	Dark gray

Note: Outer diameter of the cable must be within 2.9 to 3.4 mm. Consult nearest HRS representative for other diameters.

M Connectors

● Housing

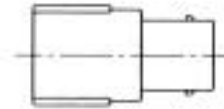
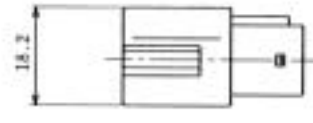
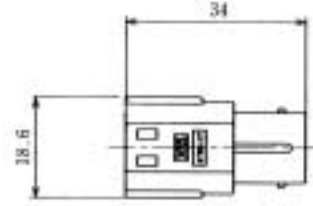

Part Number	CL No.	Part	Material	Color
GT5W-1P-HU	755-0026-0	Housing	PBT	Light gray
		Connector seal	Silicon rubber	White

Note: Use correct retainer.

● Housing - Bracket Mounting

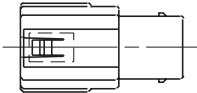
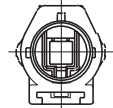
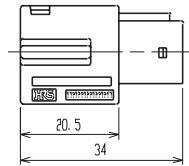
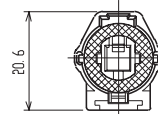
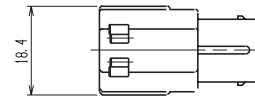

◆ Recommended Bracket Dimensions

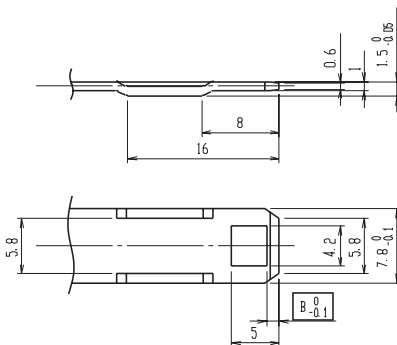

◆ Mounted and fully mated connector assemblies

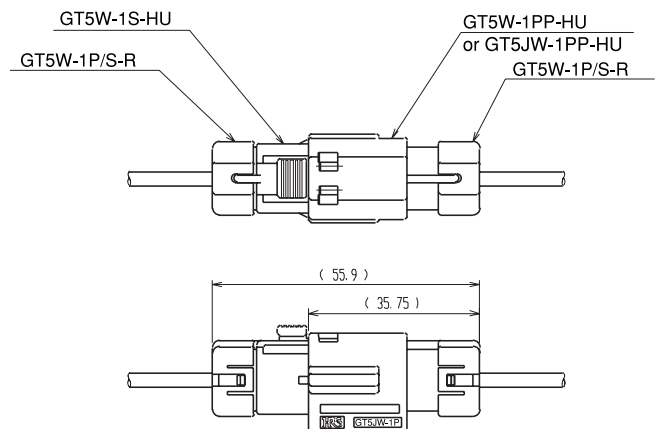

Part Number	CL No.	A	B
GT5W-1PP-HU	755-0070-1	1.5	1.3
GT5JW-1PP-HU	755-0069-2	3.2	3.0

Part	Material	Color
Housing	PBT	Light gray
Connector seal	Silicon rubber Compound	White

G Terminals

For Direct Coaxial Cable Termination

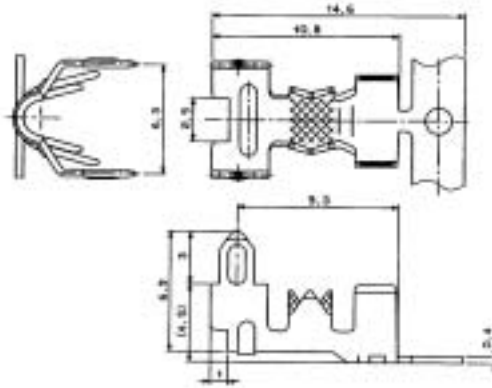

◆ Completed Termination cross section

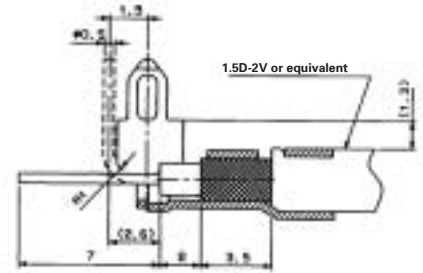

◆ Board Termination Pattern

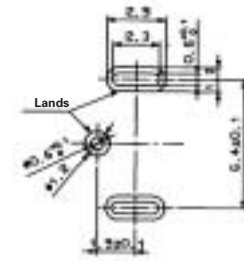

Part Number	CL No.	Material	Finish	Packaging
GTA-1.6CF	755-0032-2	Brass	Tin plating	1,500 pcs. Per reel

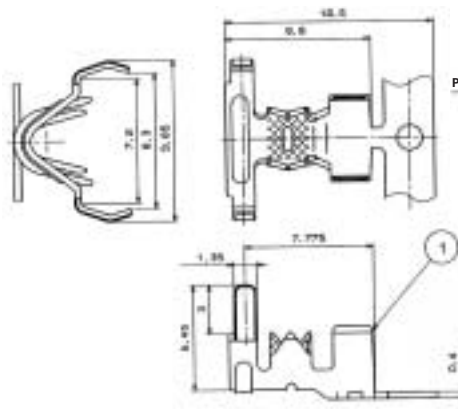

◆ Completed Termination cross section

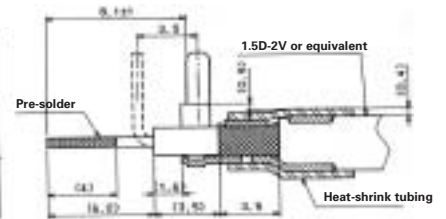

◆ Board Termination Pattern

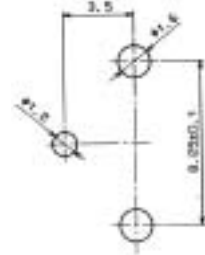

Part Number	CL No.	Material	Finish	Packaging
GTB-1.6CF	755-0049-5	Brass	Tin plating	1,500 pcs. Per reel

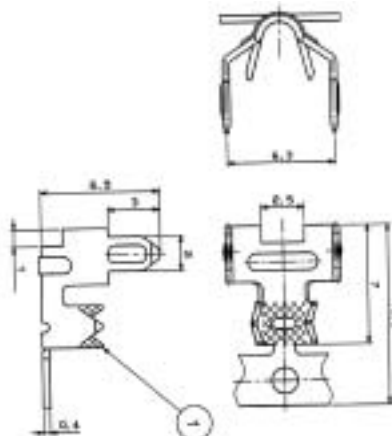

◆ Completed Termination cross section

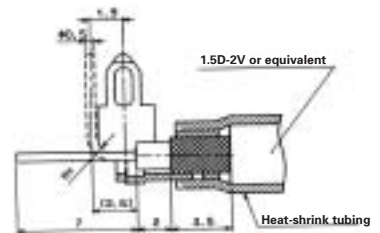

◆ Board Termination Pattern

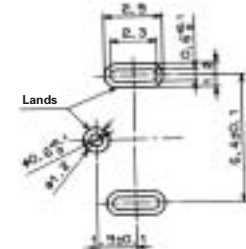

Part Number	CL No.	Material	Finish	Packaging
G-1.6PCF	755-0029-8	Brass	Tin plating	1,500 pcs. Per reel

For Direct Coaxial Cable Termination



◆ Recommended Board Termination Pattern

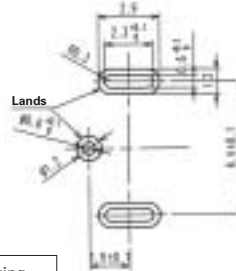

◆ Completed Termination Cross Section

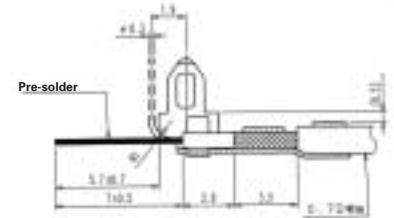

Part Number	CL No.	Material	Finish	Packaging
GTA-0.7CF	755-0074-2	Brass	Tin plating	1,500 pcs. Per reel



◆ Recommended Board Termination Pattern

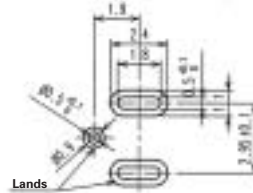

◆ Recommended Completed Termination cross section

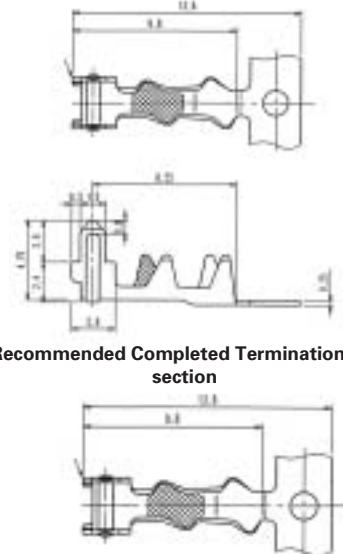

Part Number	CL No.	Material	Finish	Packaging
GTB-0.7CF	755-0075-5	Brass	Tin plating	1,500 pcs. Per reel

For Mid-Cable Termination

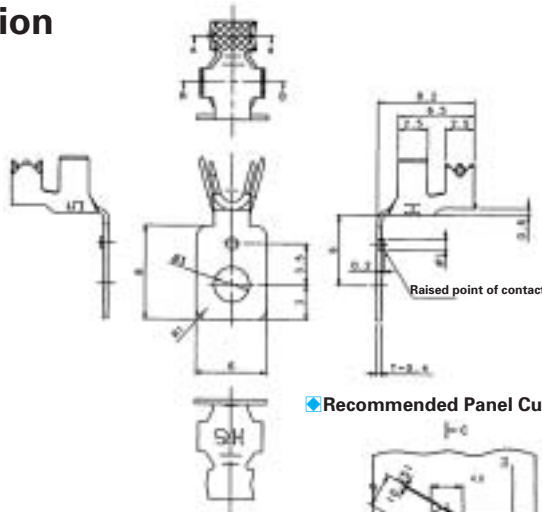

◆ Recommended Panel Cut-out

◆ Attachment Diagram

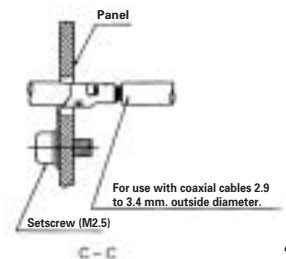
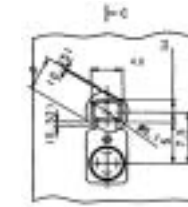

Part Number	CL No.	Material	Finish	Packaging
GT-1.6PG-C	755-0031-0	Brass	Tin plating	1

Bottom Shield cover

● For Improved Electronic Noise Compatibility

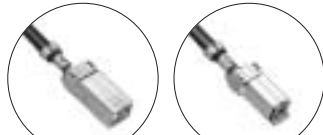

Mounted Condition Installed

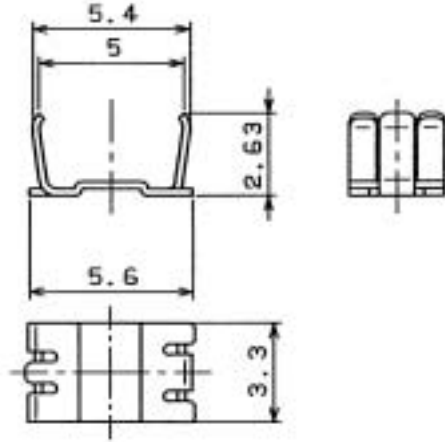

Part Number	CL No.	Material	Finish
GT5-1P/S-CSB	755-0048-2	Brass	Tin plating

Top Shield covers

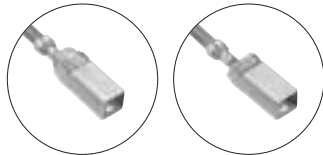
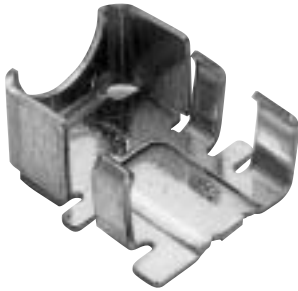

Mounted Condition Installed

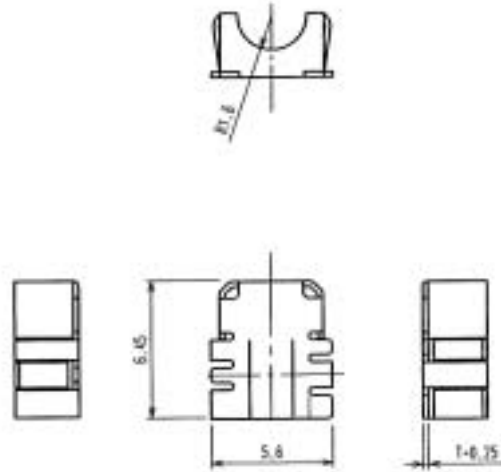

Part Number	CL No.
GT5C-1P-CSB	755-0088-7

GT5 with New Shielding Cover

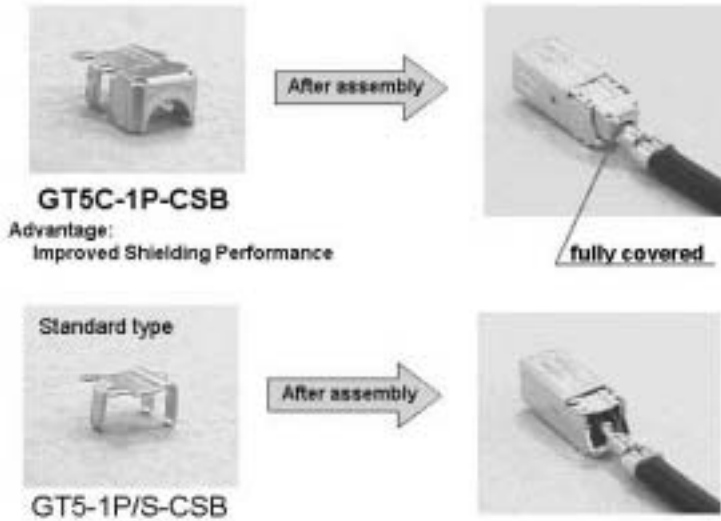

■ Panel Mounting In-line Bracket



GT-BK
GT-BK (01)

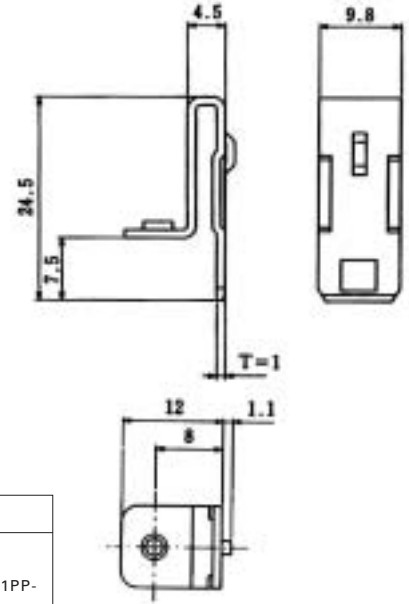

Part Number	CL No.	Material	Finish	Used with connectors
GT-BK	751-0039-6	SPCC	Tin plating	GT5-1PP-HU(A),GT5-1PP-HU(B),GT5-1PP-HU(C),GT5-1PP-HU(D),GT5-1PP-HU(E),GT5-1PP-HU(F),GT5-1PP-HU(G),GT5-1PP-HU(H),GT5-2/1PP-HU,GT5-2/1PP-HU(A),GT5-2/1PP-HU(A)
GT-BK(01)	751-0039-6-01		Zinc plating	

◆ Termination Tools

User's manuals are available. Please ask your Hirose Electric account representative.

Automatic crimping machine



Part Number CM-105

Specifications

Item	Specification	Remarks
Specification	1.5tons	
Stroke length	30mm	
Number of strokes	200spm(50Hz)	200spm(60Hz)
Weight	75kg	
Motor	0.2kW	AC100V
Crimping speed	2000 to 4000pcs. Per day	

* Crimp height setting tables are available for each cable type. Please contact your nearest Hirose Electric account representative.
Different cables will require different crimp height settings.